

Profile No	kg/m
2004	2,555

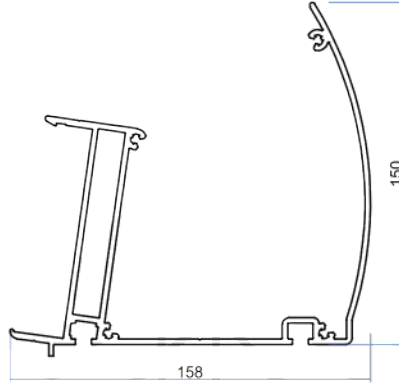

Profile No	kg/m
2012	4,113

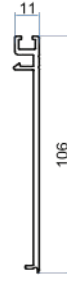

Profile No	kg/m
2011	0,890

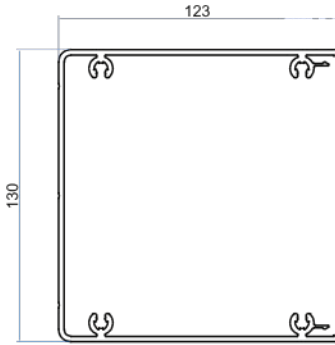

Profile No	kg/m
2009	3,050

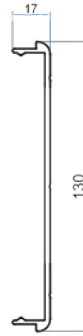

Profile No	kg/m
2010	1,025

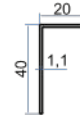

Profile No	kg/m
2394	0,177

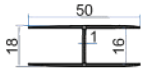

Profile No	kg/m
2539	0,290

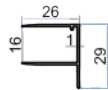

Profile No	kg/m
2538	0,210

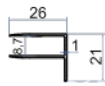

Profile No	kg/m
2542	0,180

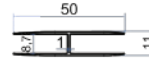

Profile No	kg/m
2543	0,230

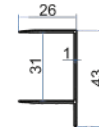

Profile No	kg/m
2544	0,240

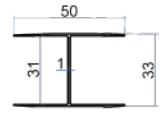

Profile No	kg/m
2545	0,285

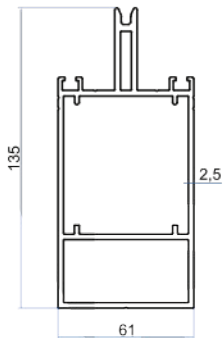

Profile No	kg/m
2005	3,230

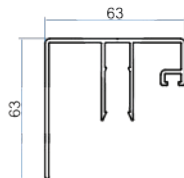

Profile No	kg/m
2008	1,060

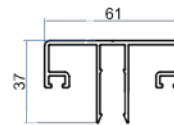

Profile No	kg/m
2007	0,925

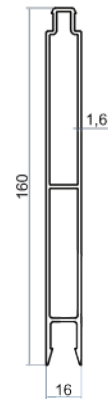

Profile No	kg/m
2546	1,591



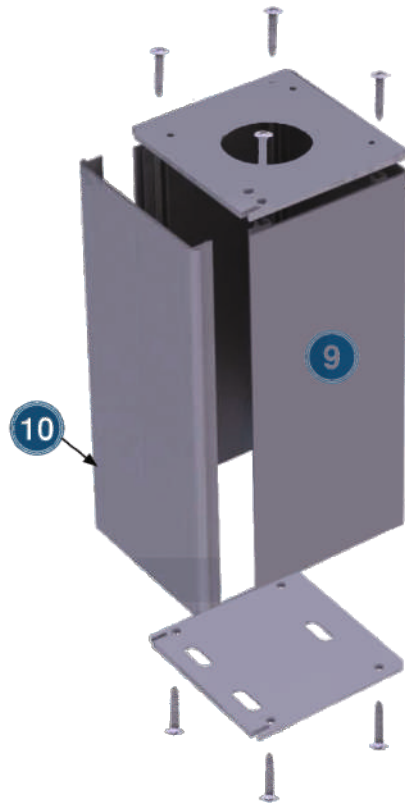
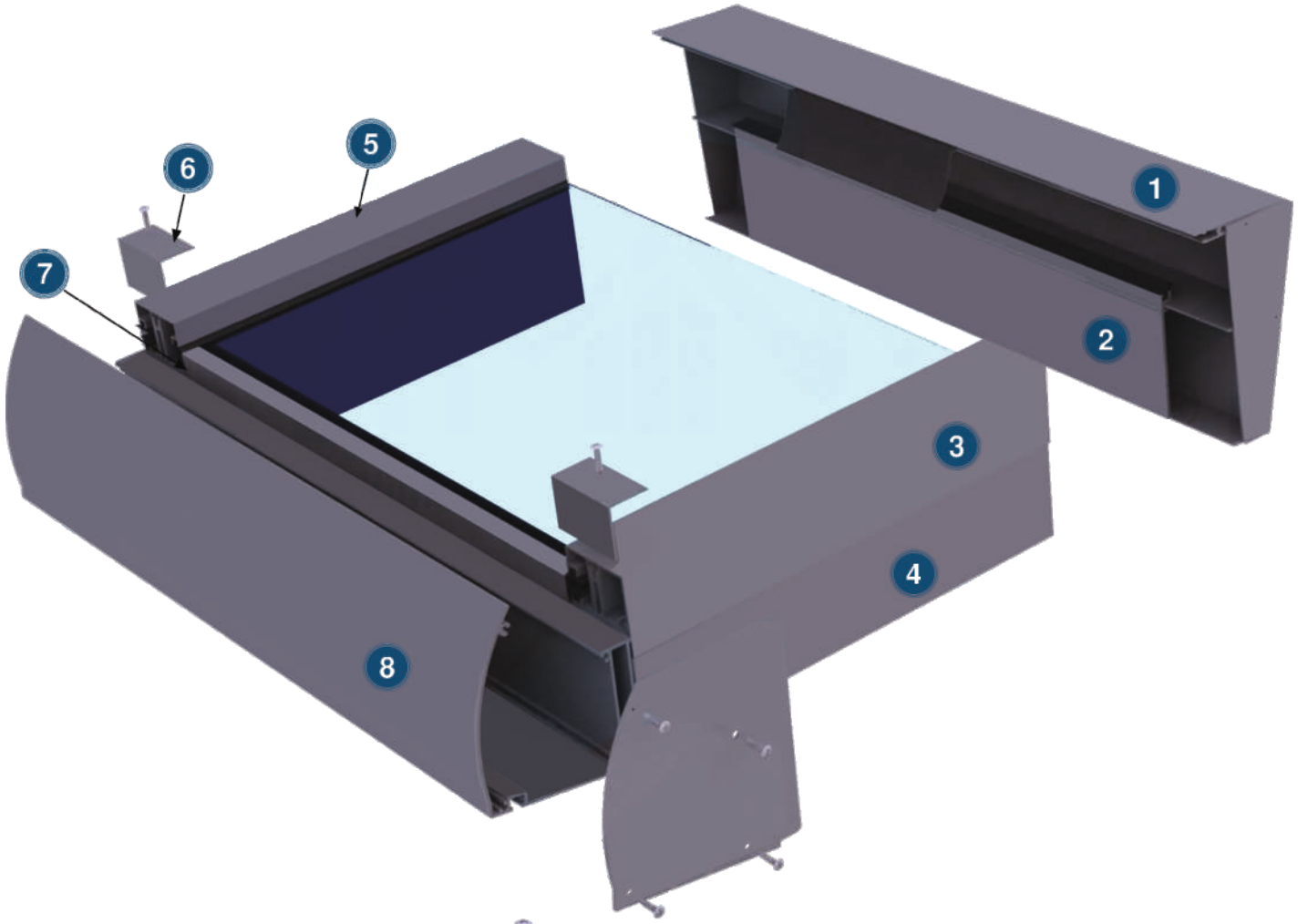

- 1 2004 NOLU PROFİL
- 2 2011 NOLU PROFİL
- 3 2008 NOLU PROFİL
- 4 2005 NOLU PROFİL
- 5 2007 NOLU PROFİL
- 6 2394 NOLU PROFİL
- 7 2542 NOLU PROFİL
- 8 2012 NOLU PROFİL
- 9 2009 NOLU PROFİL
- 10 2010 NOLU PROFİL





Kış Bahçesi Arka Askı
Winter Garden Rear Hanger

Product Code: 2004

Weight kg/m: 2,555
(187 x 69 x 3mm)

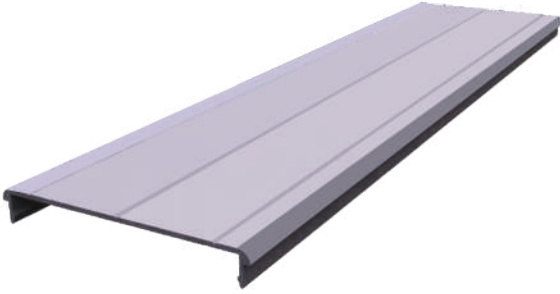

Kış Bahçesi Ayak Kapak Profili
Winter Garden Foot Cover Profile

Product Code: 2010

Weight kg/m: 1,025
(130 x 17 x 2,4mm)

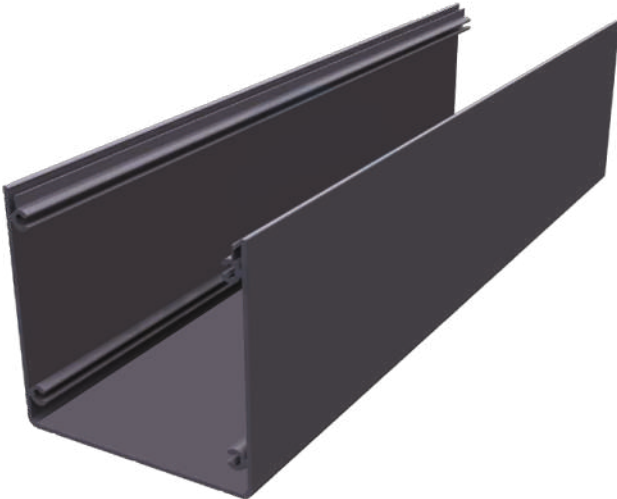

Kış Bahçesi Ayak Profili
Winter Garden Foot Profile

Product Code: 2009

Weight kg/m: 3,050
(130 x 124 x 2,4mm)



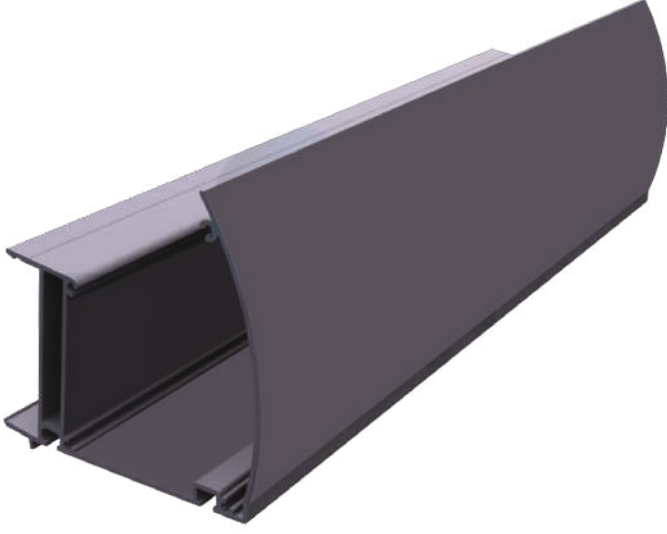

Kış Bahçesi Radüs Oluk
Winter Garden Radius Gutter

Product Code: 2012

Weight kg/m: 4,113
(150 x 158 x 2,5mm)

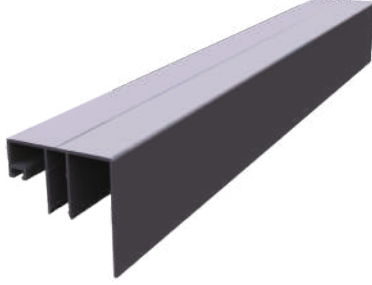

**Kış Bahçesi Kapak Profili
(Sağ ve Sol)**
*Winter Garden Cover Profile
(Right and Left)*

Product Code: 2008

Weight kg/m: 1,060
(63 x 63 x 1,8mm)



Kış Bahçesi Kapak Profili
Winter Garden Cover Profile

Product Code: 2007

Weight kg/m: 0,925
(37 x 63 x 1,8mm)



Kış Bahçesi Cam Tutucu
Winter Garden Glass Holder

Product Code: 2005

Weight kg/m: 3,230
(135 x 61 x 2,5mm)



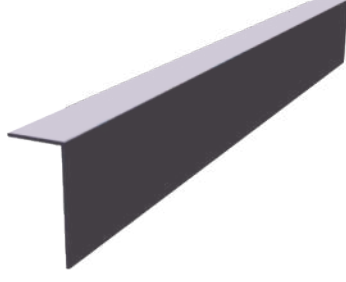

Kış Bahçesi Köşebent
Winter Garden Bracket

Product Code: 2394

Weight kg/m: 0,177
(40 x 20 x 1,1mm)



Kış Bahçesi Oluk ve Arka İç Kapak
*Winter Garden Gutter and
Rear Inner Cover*

Product Code: 2011

Weight kg/m: 0,890
(106 x 11 x 2,6mm)



15x160 Lambiri
15x160 Paneling

Product Code: 2546

Weight kg/m: 1,591
(160 x 16 x 1,6mm)

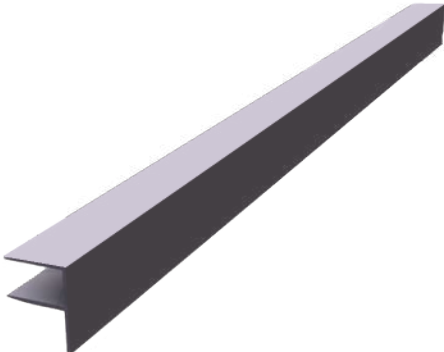

8mm F Profil
8mm F Profile

Product Code: 2542

Weight kg/m: 0,180
(21 x 26 x 1mm)



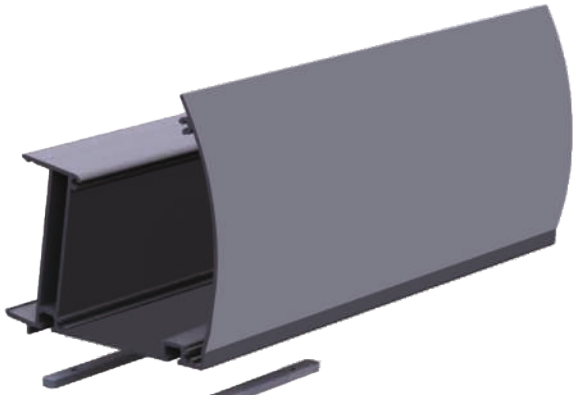
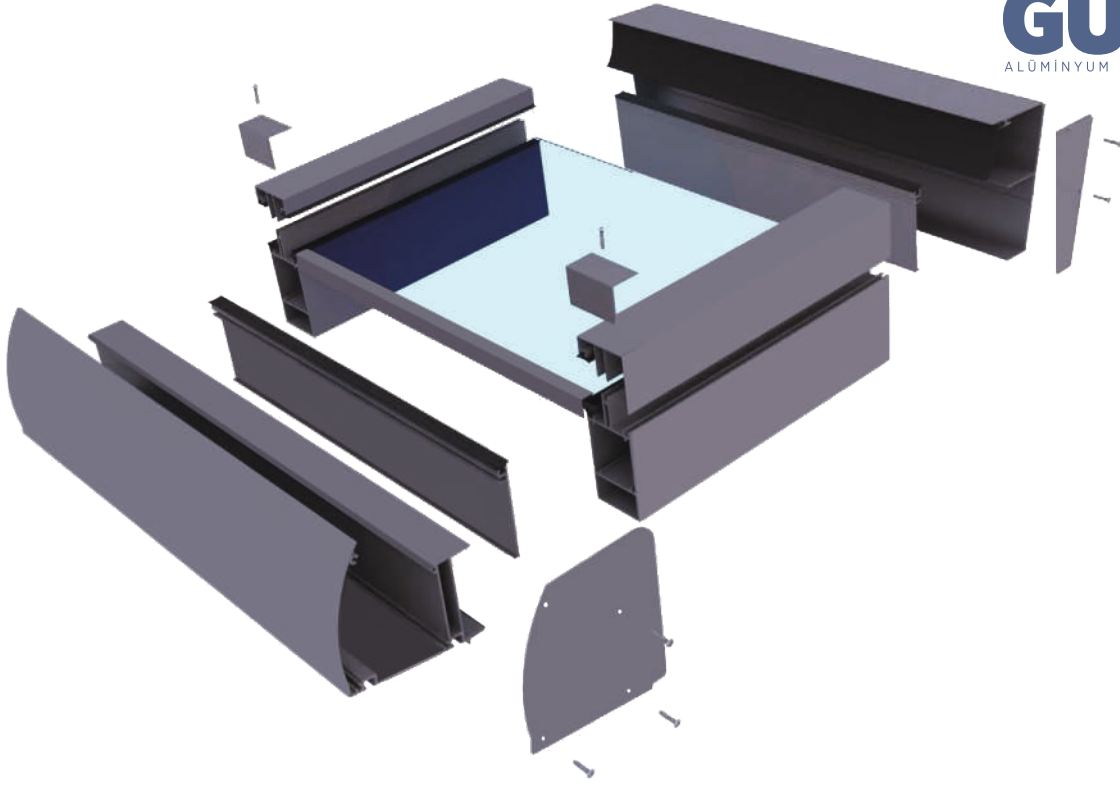

ANTORYUM OVAL KERTME İŞLEMİ
ANTORYUM OVAL LOSS OPERATION

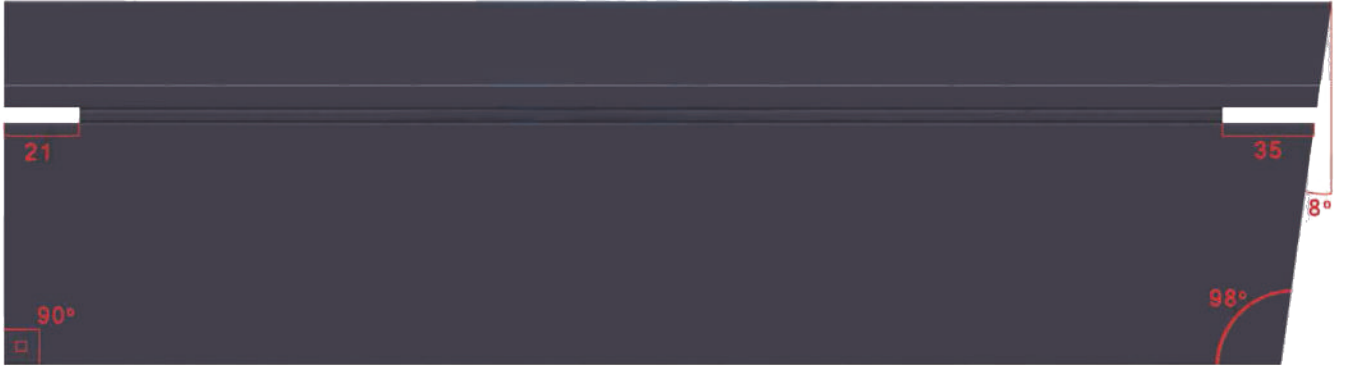
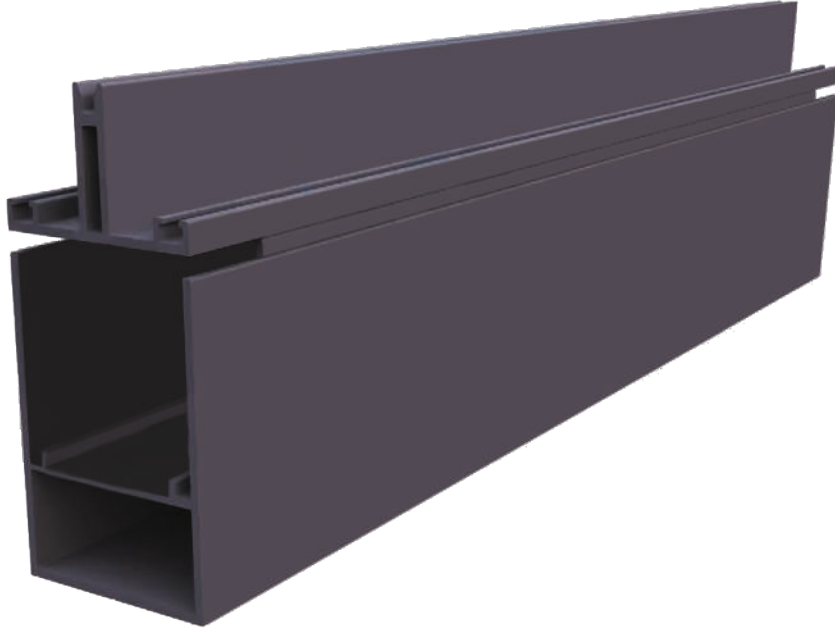

ÖN
FRONT

ARKA
REAR

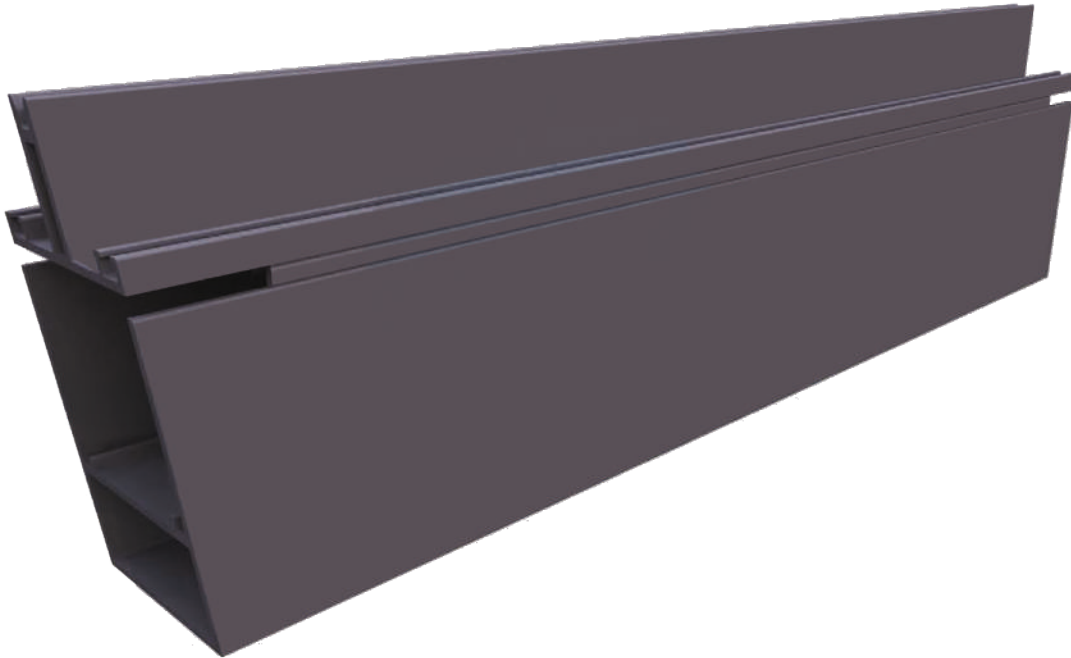

ANTORYUM OVAL AYAK BAĞLANTI
ANTORYUM OVAL FOOT CONNECTION

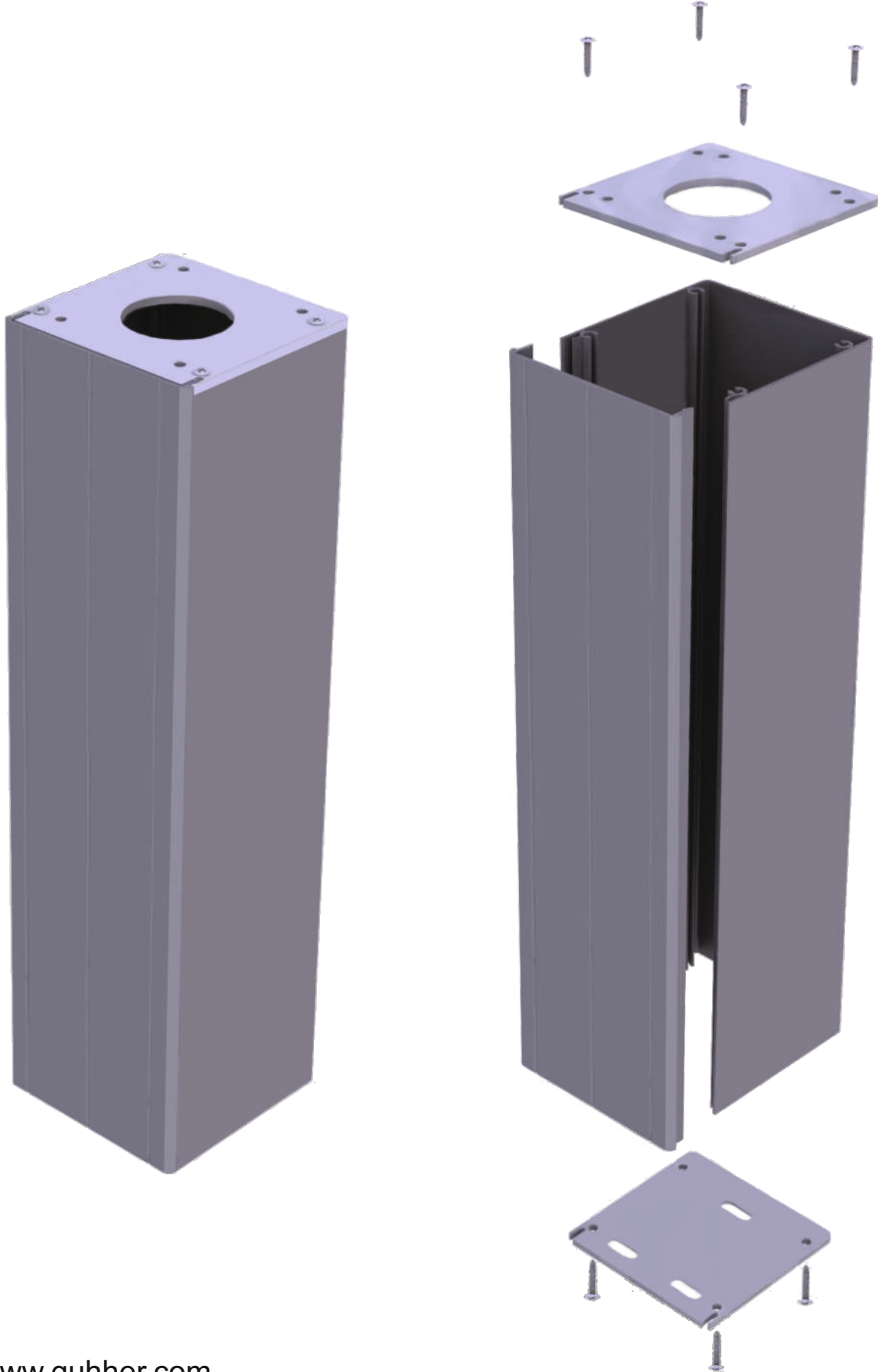



Baskı Contası
Print Gasket

Product Code: KIS-09

1 Top: 174 mt/15 kg
1 Roll: 174 mt/15 kg



Arka Baskı Contası
Back Print Gasket

Product Code: KIS-10

1 Top: 41 mt/15 kg
1 Roll: 41 mt/15 kg



75'lik Filtre
75 Filter

Product Code: KIS-08



24V / 5A Led Trafo
24V / 5A Led Transformer

Product Code: KIS-21



24V Led
24V Led

Product Code: KIS-22

Box Piece: 100
Box Piece: 100



10x80 Çelik Lama
10x80 Steel Flat Bar



2x0.75 Nyaf Kablo
2x0.75 Nyaf Cable

Product Code: KIS-23

1 Top: 100 mt
1 Roll: 100 mt



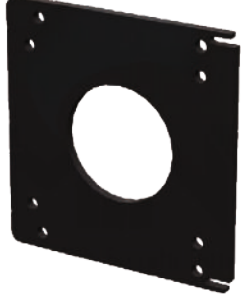

Kapaklı Ayak Üst Bağlantı Sacı
Covered Foot Top Connection Plate

Product Code: KIS-02

Kalıp No: 2009, 2010 Nolu Profilde kullanılır.
Mold Number: Used in profile no 2009, 2010



Kapaklı Ayak Alt Bağlantı Sacı
Covered Foot Bottom Connection Plate

Product Code: KIS-03

Kalıp No: 2009, 2010 Nolu Profilde kullanılır.
Mold Number: Used in profile no 2009, 2010



Arka Askı Sacı
Rear Hanger Plate

Product Code: KIS-04

Kalıp No: 2004 Nolu Profilde kullanılır.
Mold Number: Used in profile no 2004



Oval Oluk Sacı
Oval Gutter Sheet

Product Code: KIS-05

Kalıp No: 2012 Nolu Profilde kullanılır.
Mold Number: Used in profile no 2012



Lama Somun Sacı
Lama Nut Sheet

Product Code: KIS-06

2012 Oluk Kapaklı Ayak Bağlantı
2012 Gutter Covered Leg Connection



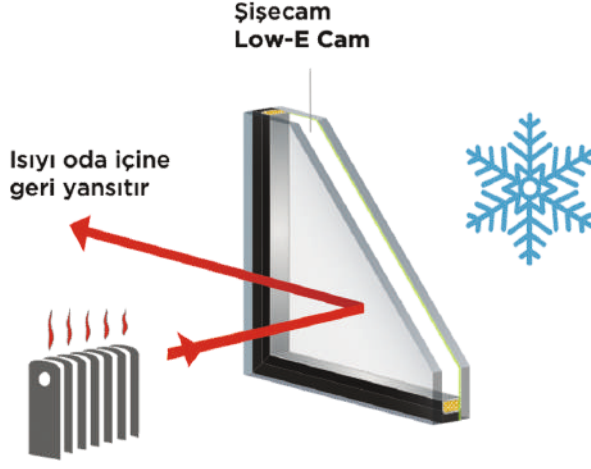

Isıcam
Insulating Glass

ANTORYUM OVAL
Minimum 8mm - Maximum 24 mm

ANTORYUM FLAT
Minimum 8mm - Maximum 32 mm

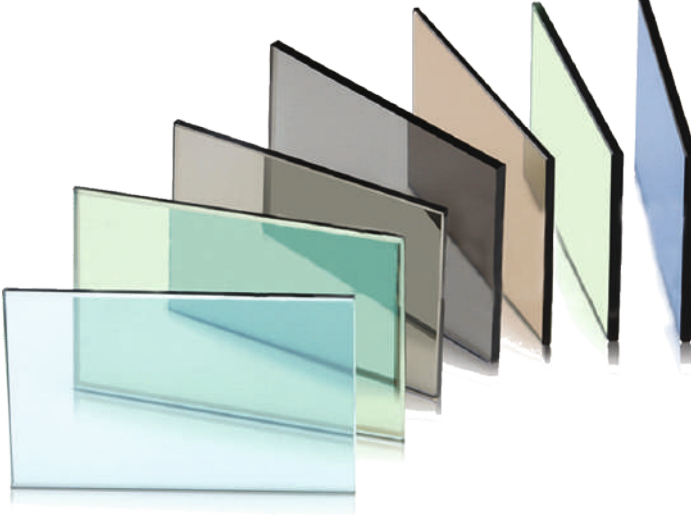

Lamine Cam
Laminated Glass

ANTORYUM OVAL
Minimum 8mm - Maximum 12 mm

ANTORYUM FLAT
Minimum 8mm - Maximum 12 mm

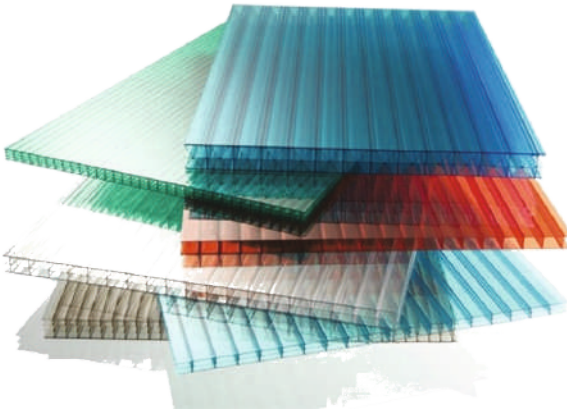

Polikarbon
Polycarbonate

ANTORYUM OVAL
Minimum 8mm - Maximum 24 mm

ANTORYUM FLAT
Minimum 8mm - Maximum 32 mm





